



**RINSEGARD® HP AND HPX
CARTRIDGE AND DISPOSABLE FILTERS**

Simultaneously removes trace levels of positively charged ions and fine particles in ultrapure DI water



hydrophilic membrane offers superior particle removal

Overview

Rinsegard® HP/HPX filters optimize wafer quality by removing trace metallic ions, even from ultrapure water. Trace metals in ultrapure water — at the wet etch, clean process, and especially the rinse stages — can increase metal contamination of the wafer and decrease minority carrier lifetime measurement. Detection of low concentrations of trace metals presents a challenge as conventional resistivity monitoring equipment cannot accurately measure or monitor trace metallic ions in the low parts-per-trillion (ppt) range.

Rinsegard HP/HPX filters, utilize a patented, hydrophilic UPE membrane. The Rinsegard filters remove a finite mass of multivalent metal ions and particles from ultrapure water and offer superior particle performance.

Simple Installation and Replacement

Rinsegard HP/HPX filters simplify filter changeout and minimize downtime. The patented hydrophilic membrane (UPE) eliminates the need for prewetting or flushing, and the large filtration area of the HPX filter enhances membrane retention and flow.

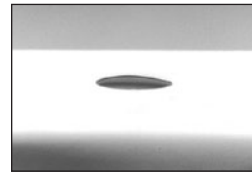

Aqueous chemicals instantly wet Rinsegard hydrophilic UPE membrane

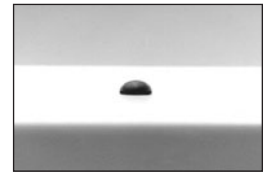

PTFE membrane resists instantaneous wetting

Features	Benefits
Hydrophilic, patented UPE membrane increases equipment uptime, and provides better, more consistent performance.	Eliminates prewetting and flushing. Saves time at changeout,
Multifunctional membrane with the ability to eliminate ions and particles and reduces waste. Removes particles with greater than	Eliminates trace levels of ions and improves quality of ultrapure water. Decreases metal contamination on wafer, 99.9% efficiency at stated retention rating.
Available in retention ratings of 0.05 μm , 0.1 μm and 0.2 μm	Excellent small particle retention: ensures minimal particles on wafer.
High membrane-area cartridge, with low pressure drop across the membrane	High flow and efficient particle removal: ensures rapid particle removal in one-pass and recirculating applications.
All-polyethylene construction	Provides excellent chemical compatibility, long lifetime, reduced changeout and system startup times.
Available in 4", 10", 20" and 30" cartridge sizes as well as disposable filter options	Designed to fit the flow and process needs and space constraints for wide variety of customers and original equipment manufacturing (OEM) suppliers.

Specifications

Type		HP	HPX	
Materials:	Membrane	Patented hydrophilic ultra-high molecular weight polyethylene (UPE)	Patented hydrophilic ultra-high molecular weight polyethylene (UPE)	
	Supports, sleeve, core, end caps	Nonwoven high-density polyethylene (HDPE)	Nonwoven high-density polyethylene (HDPE)	
	Code O double 2-222 o-rings	Teflon® encapsulated Viton® (TEV), or EPDM	Teflon encapsulated Viton (TEV), or EPDM	
	Chem-Line™ II disposables outer shell	N/A	Polypropylene	
	Chem-Line I disposables outer shell	N/A	PFA	
Retention rating:		0.2, 0.1, 0.05 µm	0.2, 0.1, 0.05 µm	
Membrane surface area:		10": 0.85 m ²	4": 0.5 m ² 10": 1.1 m ² 20": 2.2 m ² 30": 3.3 m ²	
	Maximum operating conditions:	Maximum forward differential pressure	0.35 MPa (3.5 bar; 50 PSID) @ 25°C (77°F)	0.35 MPa (3.5 bar; 50 PSID) @ 25°C (77°F)
		Maximum reverse differential pressure	0.35 MPa (3.5 bar; 50 PSID) @ 25°C (77°F)	0.35 MPa (3.5 bar; 50 PSID) @ 25°C (77°F)
		Maximum operating temperature	Cartridges 60°C (140°F) at the above conditions Disposables 70°C (158°F) at the above conditions	
Cleanliness:	<2 particles/mL >0.2 µm after 5-minute flush DI water @ 5 L/min			
Compatibility:	Designed for ultrapure DI water. Not compatible with ozone.			

Rinsegard HP, HPX Cartridge Filters

Nominal Dimensions

Rinsegard HP Cartridge Filters

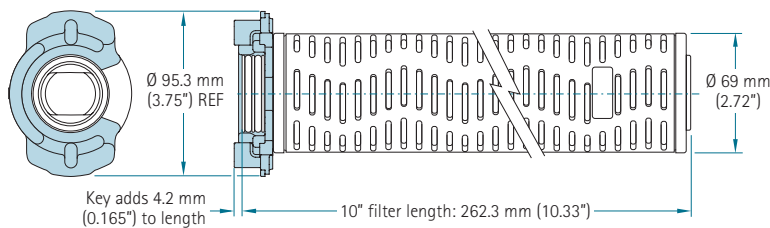

Rinsegard HPX Cartridge Filters

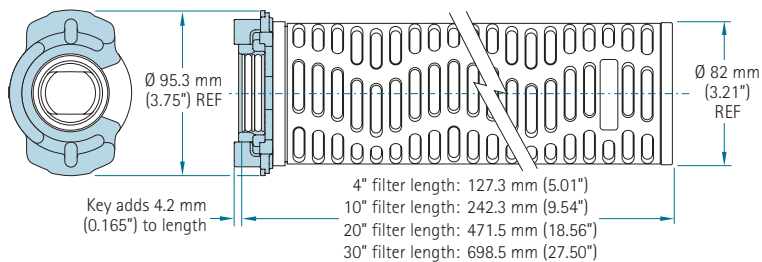

Performance Data

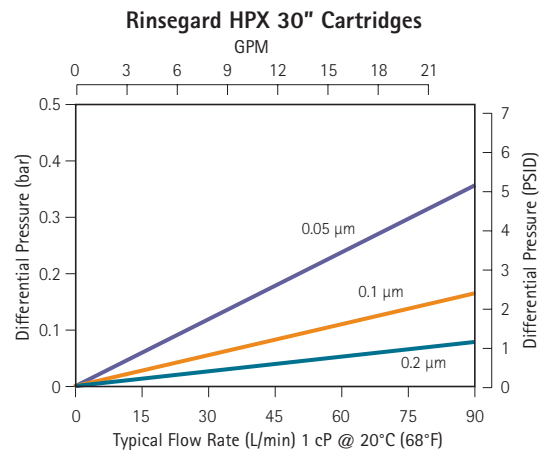
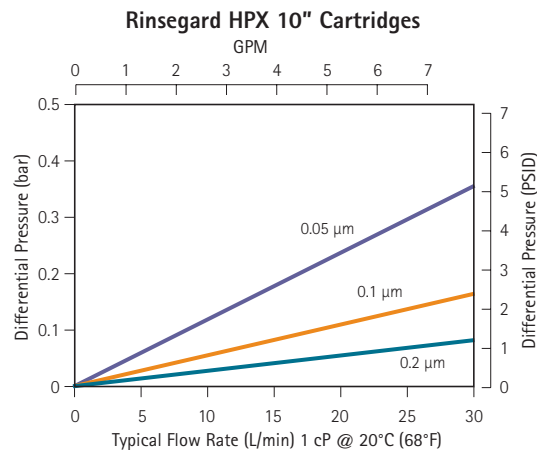
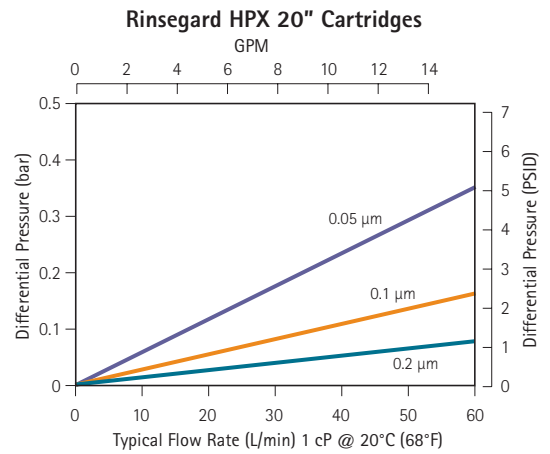
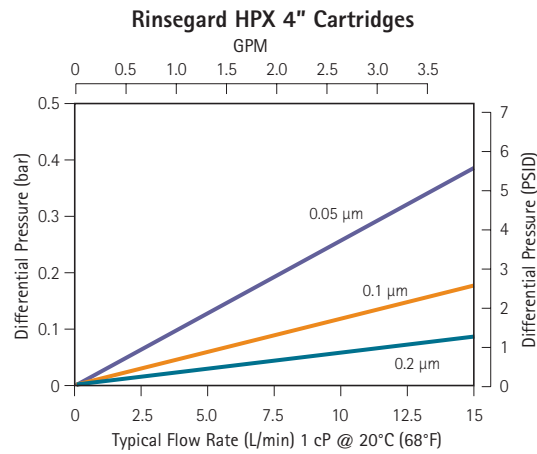
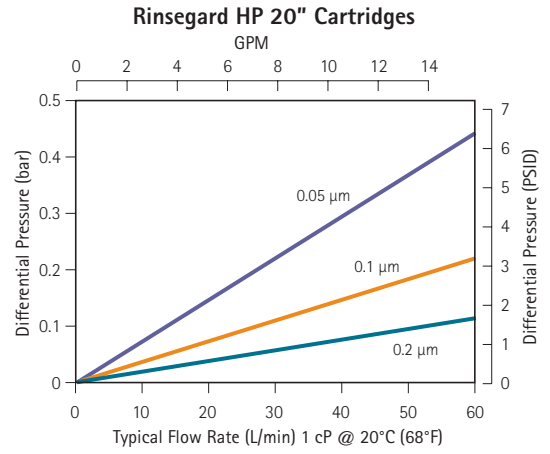
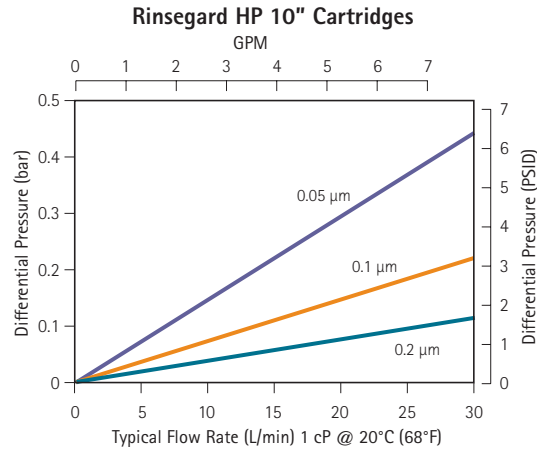

Rinsegard Disposable Filters

Nominal Dimensions

Chem-Line I Disposable Filters

TH: T-Line 3/4" Super Type Pillar® Fittings

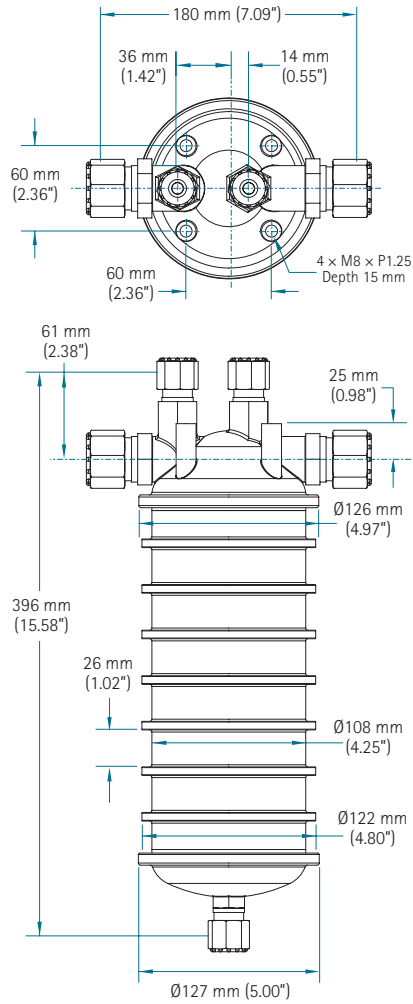

Chem-Line II Disposable Filters

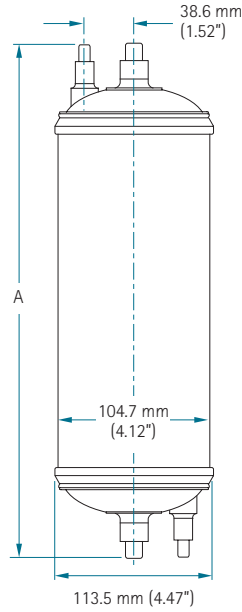

Inlet/ Outlet Size	Dim A	
	4" Disposable Filter with Flaretek® Compatible Fittings	10" Disposable Filter with Flaretek Compatible Fittings
3/4"	247.9 mm (9.72")	359.9 mm (14.17")
1"		370.1 mm (14.57")

Performance Data

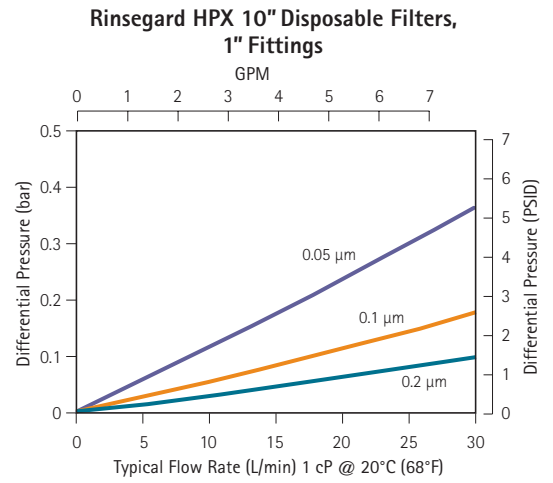
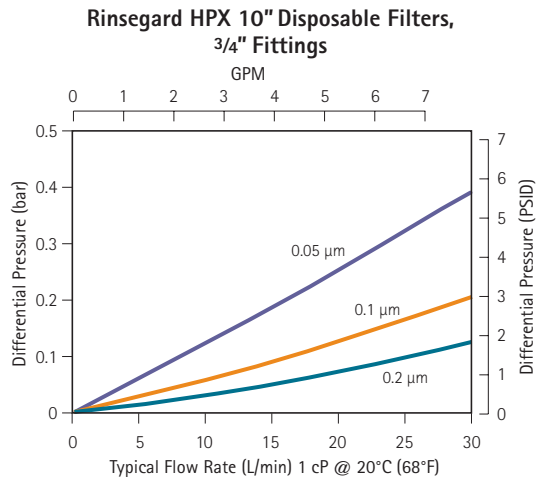
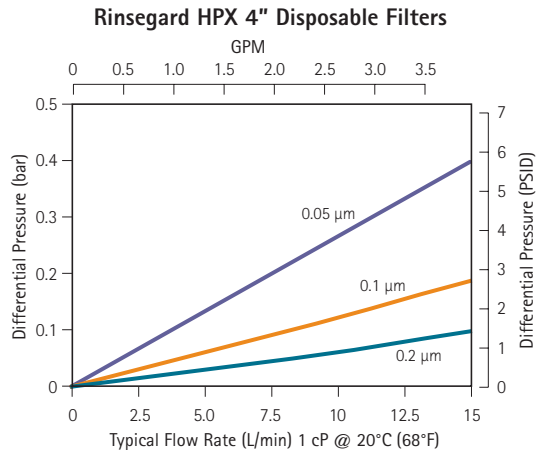

Ordering Information

Rinsegard HP Cartridge Filters

Part Number

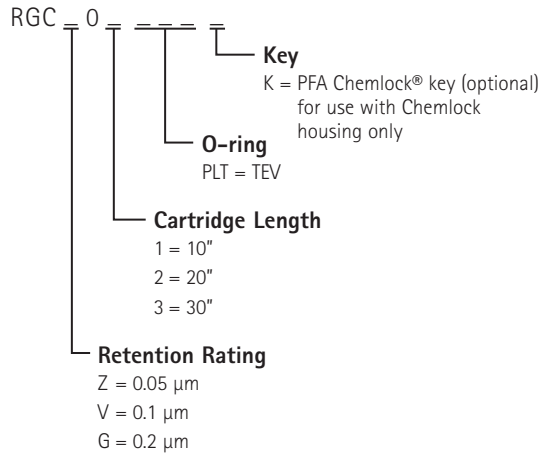

Rinsegard HPX Chem-Line II Disposable Filters

Part Number

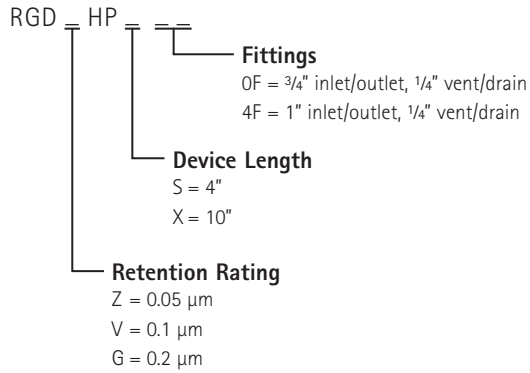

Rinsegard HPX Cartridge Filters

Part Number

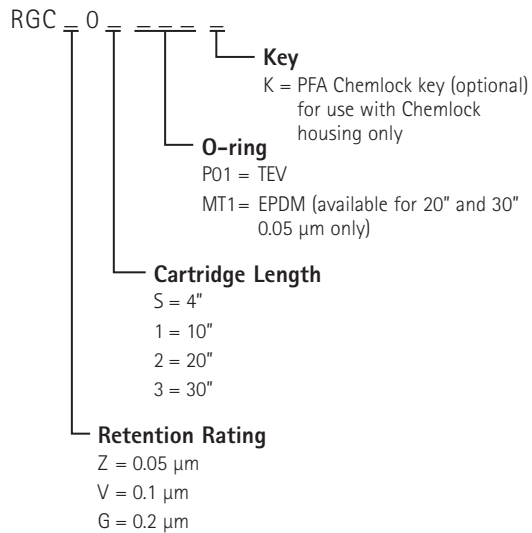

Rinsegard HPX Chem-Line I Disposable Filters

Part Number

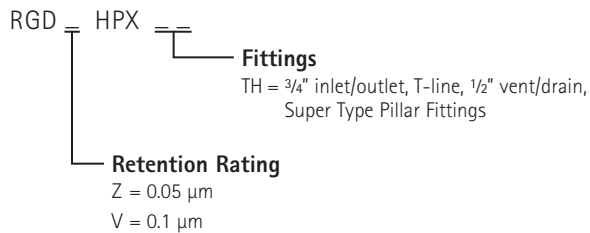

For More Information

Please call your Regional Customer Service Center today to learn what Entegris can do for you. Visit www.entegris.com and select the “Customer Service” link for the center nearest you.

Terms and Conditions of Sale

All purchases are subject to Entegris’ “Terms and Conditions of Sale.” To view and print this information, visit Entegris’ website at www.entegris.com and select the Legal Notices link from the footer found on the home page.

Entegris®, Rinsegard®, Chemlock®, Flaretek® and Chem-Line™ are trademarks of Entegris, Inc.
Teflon® is a registered trademark of E.I. du Pont de Nemours and Company.
Viton® is a registered trademark of DuPont Dow Elastomers, L.L.C.
Pillar® is a registered trademark of Nippon Pillar Packaging Company, Ltd.

ENTEGRIS, INC.

Corporate Headquarters | 129 Concord Road | Billerica, MA 01821 USA
Customer Service Tel. +1 952 556 4181 | Customer Service Fax +1 952 556 8022
In North America 800 394 4083 | www.entegris.com